



SIGMA

DRILLING TECHNOLOGIES

HOW TO SERVICE MUD PUMP DAMPENERS

1

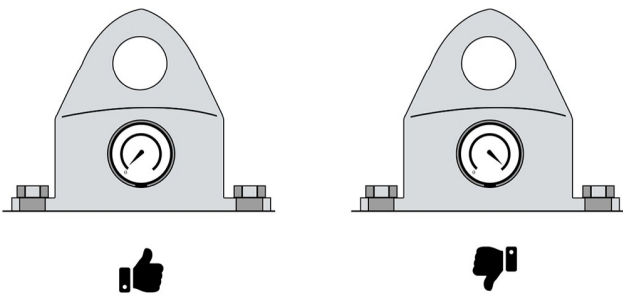

Make sure operational pressure is at zero PSI.

2

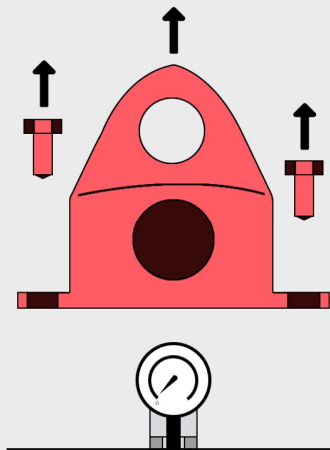

Remove the dust cover from the top of the dampener, if present

3

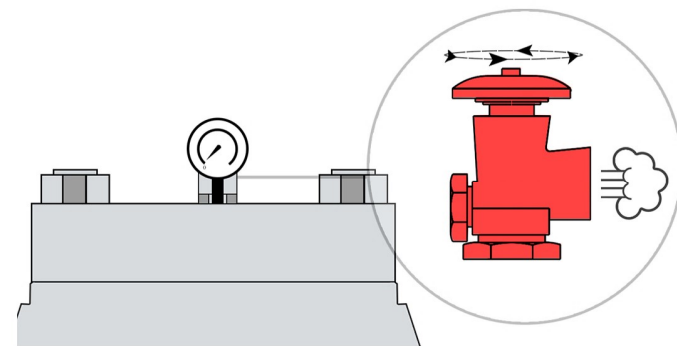

Open the charging valve on top of the dampener to remove any existing pre-charge pressure

4

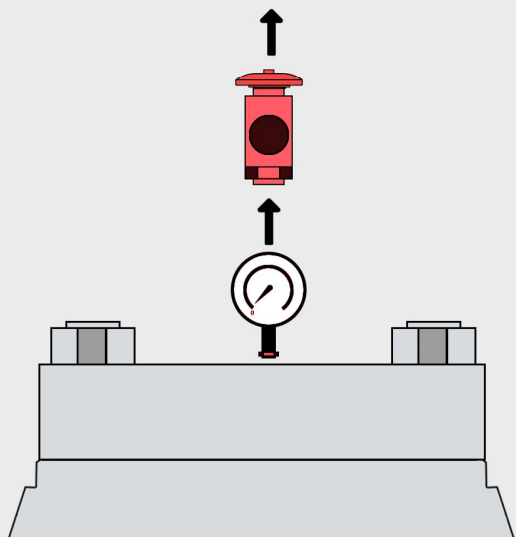

Once pressure is completely drained, remove charging valve and pressure gauge

5

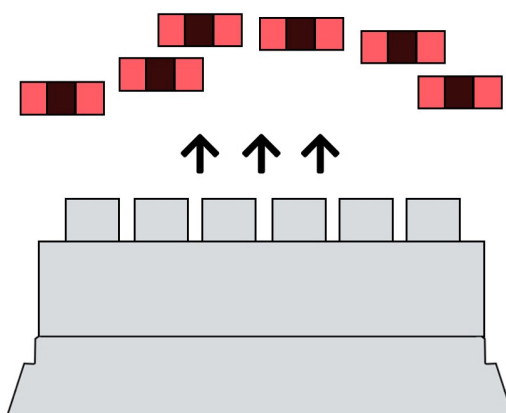

Remove nuts securing cover plate

6

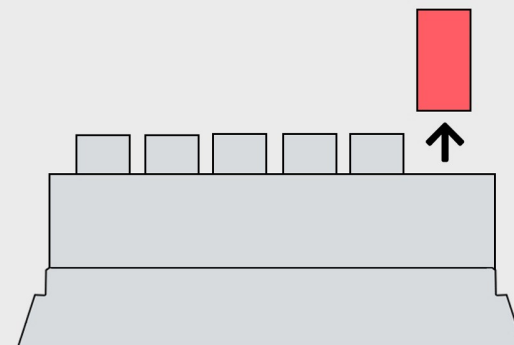

Remove one stud from the body of the dampener

7

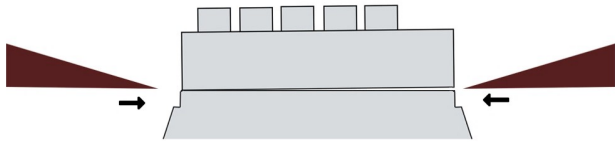

Use a wedge to “free” the cover plate from the body of the dampener

8

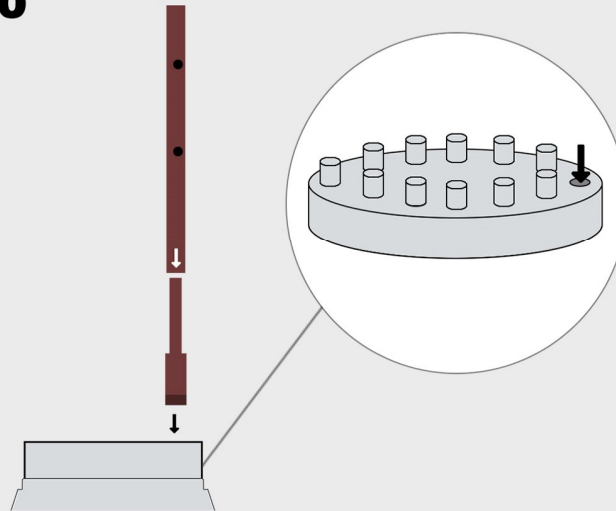

Insert *Sigma Service Pole** into dampener body through coverplate

**You can purchase the Sigma Service Pole here:
<https://www.sigmadrillingtech.com/product/sigma-service-pole/>*

9

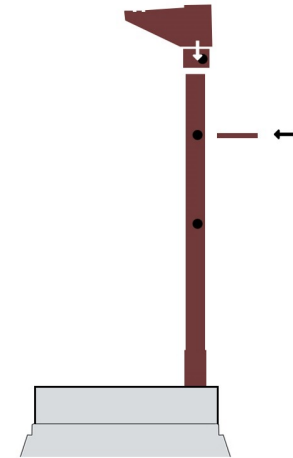

Attach lifting arm to *Sigma Service Pole**

10

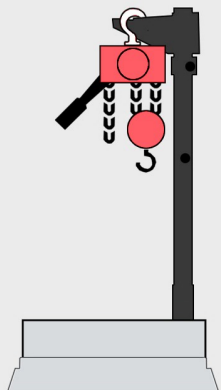

Attach lifting hoist to *Sigma Service Pole** lifting arm

11

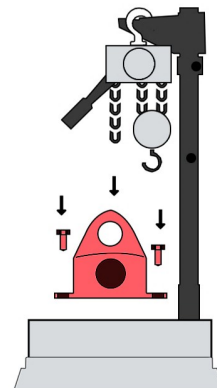

Reinstall dust cover (If this is your lifting point)

12

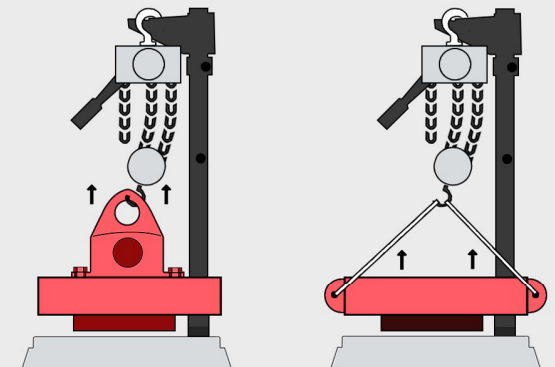

Attach lifting straps to lifting points and lift cover plate

13

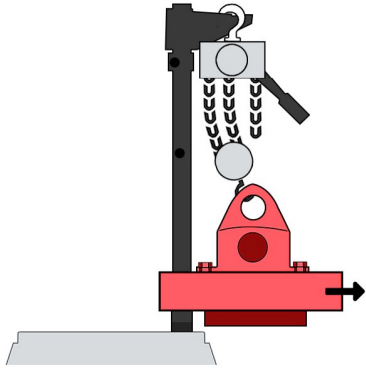

Rotate cover plate away from body

14

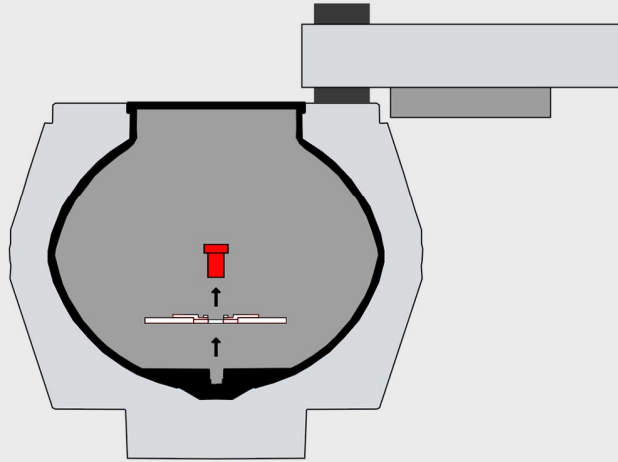

Remove old stabilizer plate from inside old bladder

15

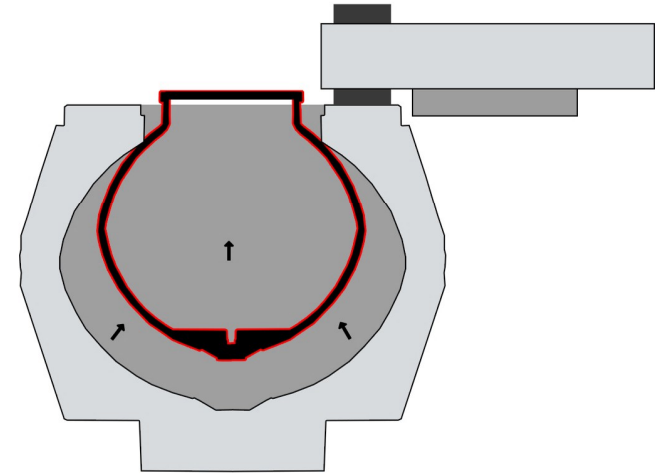

Remove old bladder

16

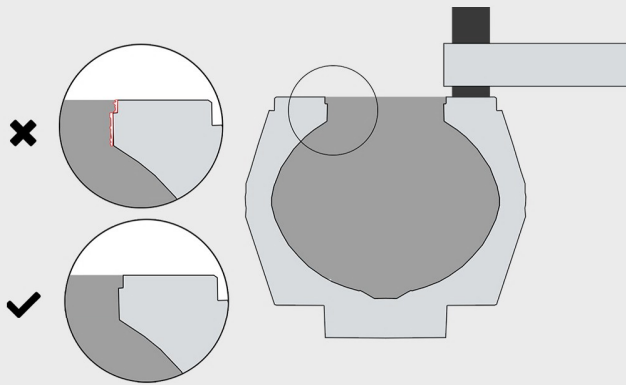

Clean the throat of the dampener body and inspect for sharp edges or shards

17

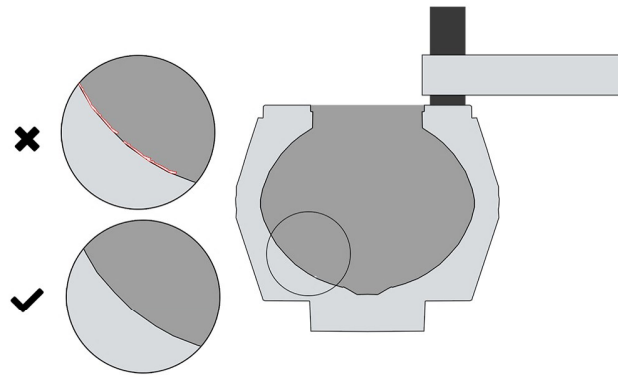

Visually inspect the interior of the body for sharp burs or missing material

18

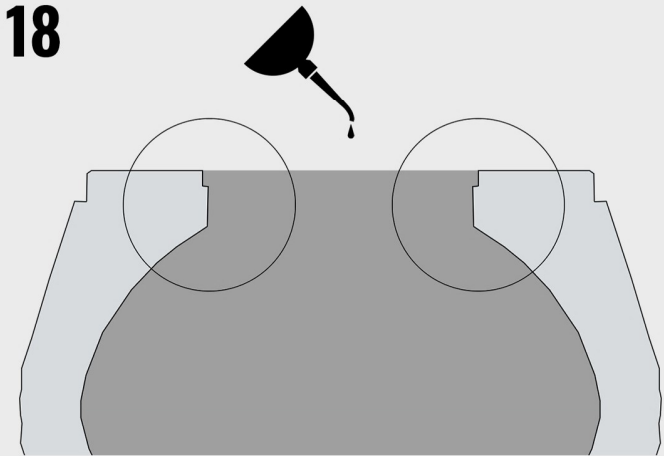

Lightly lubricate the inside throat of the dampener

19

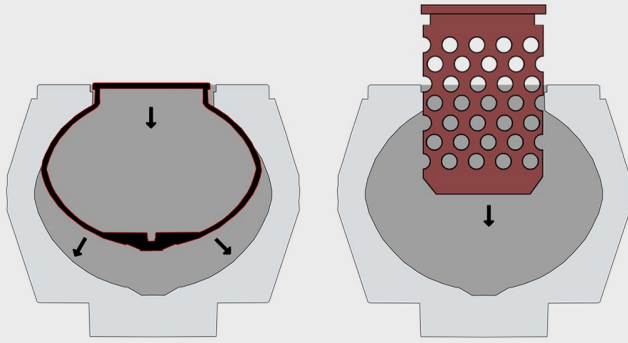

Insert new bladder or Sigma Suspension Bag

20

IF BLADDER

- Extend bladder to the bottom of dampener
- Insert stabilizer plate inside bladder
- Take steel stabilizer plate and bolt and fasten the stabilizer plate to the plug in the bottom of the bladder

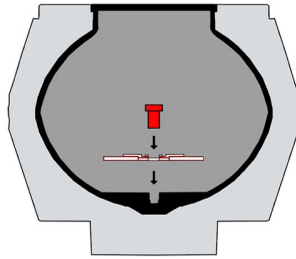

Secure bladder or suspension bag collar on the indented shelf on the body opening

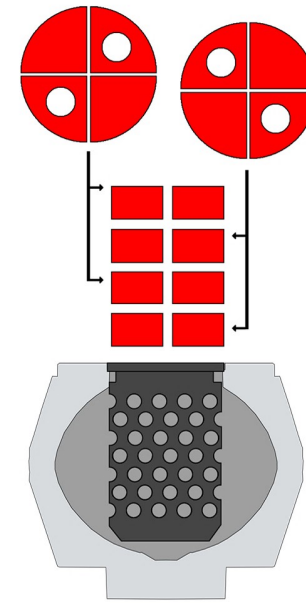

IF SIGMA CFC KIT

- Insert compression wedges in offsetting pattern
- Layer one = offset pattern, layer two = opposite offsetting pattern
- Continue through all four layers

21

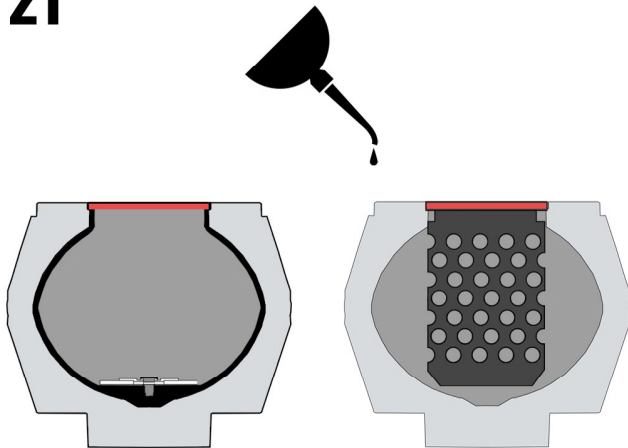

Lightly lubricate the ID of the collar. Do not lubricate the top of the collar as this is the sealing surface.

22

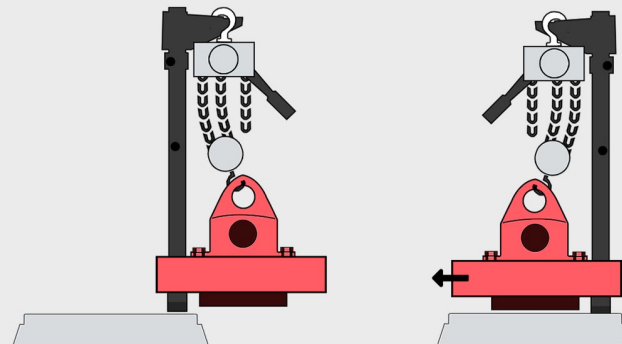

Rotate cover plate back over dampener body

23

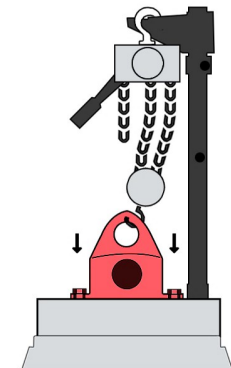

Slowly lower the cover plate straight down onto the body of the dampener

24

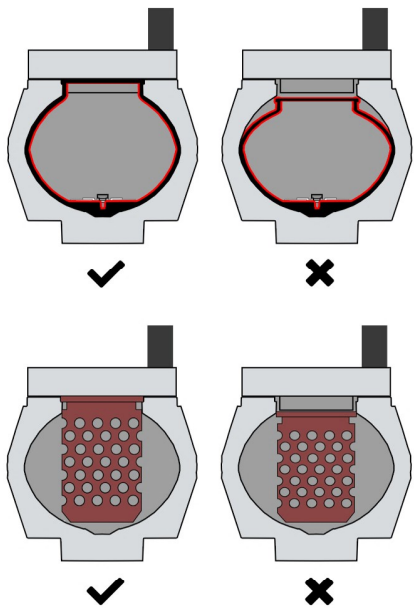

As cover plate is being lowered, insure the collar of the bladder or suspension bag stays secure on the shelf on the body opening

25

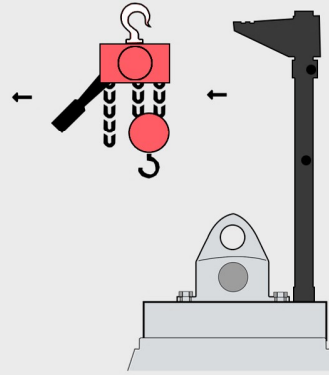

Disconnect lifting straps and hoist from Sigma service pole arm

26

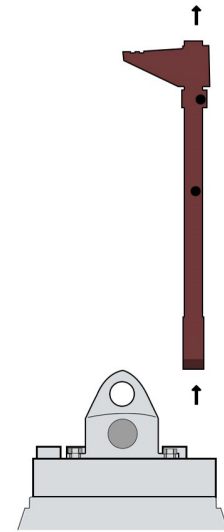

Remove Sigma service pole

27

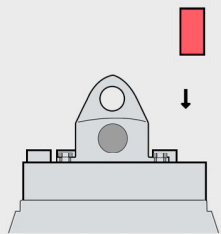

Lubricate stud with copper grease and reinsert stud into dampener body

28

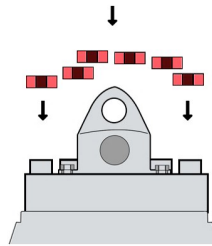

Lubricate all stud threads & nut threads with copper grease and reinstall nuts

29

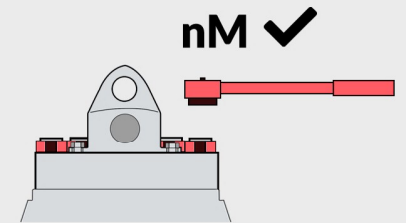

Torque all the nuts to the proper manufacturers' torque value in cross pattern

30

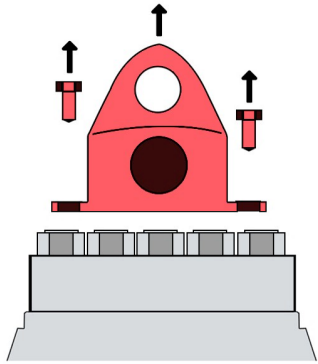

Remove dust cover

31

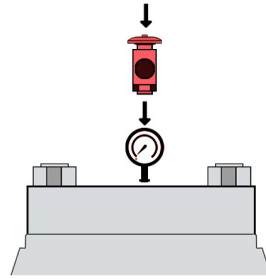

IF BLADDER

- Reattach working pressure gauge
- Reattach working charge valve

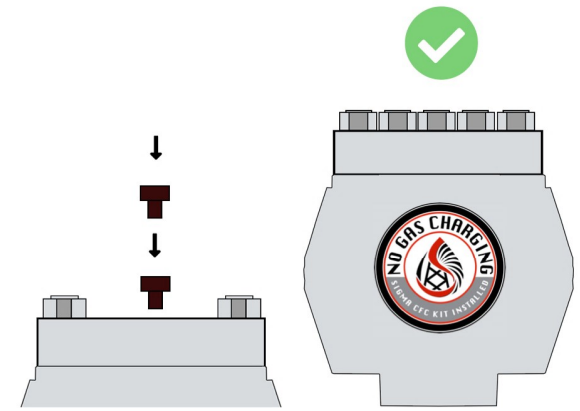

IF SIGMA CFC KIT

- Replace valve and gauge with plugs
- Place CFC Kit Sticker on Dampener
- **You are ready for operations**

32

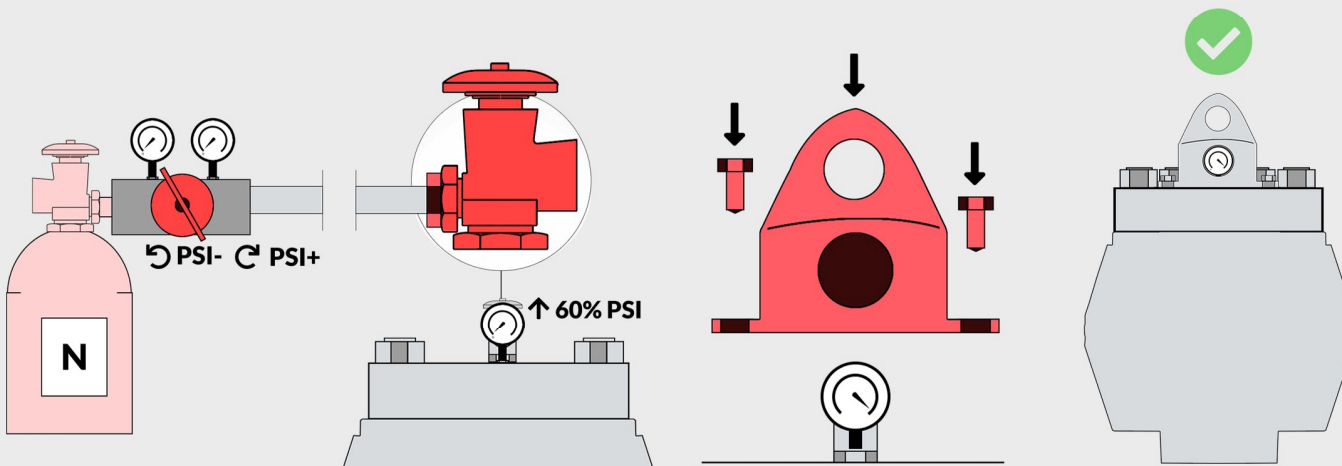

Reattach dust cover

- Determine target operational pressure
- Get several nitrogen bottles - ****Safety Warning**** Make sure you are using nitrogen only
- Pre-charge bladder to 60% of desired operational pressure – For optimal performance, make sure you adjust pre-charge to match operational pressure conditions

- **You are ready for operations**



- 📄 www.sigmadrillingtech.com
- ✉ sales@sigmadrillingtech.com
- 📞 (281) 656-9298